

Heterojunction Bipolar Transistor (InGaP HBT)

Broadband High Linearity Amplifier

The MMG3011NT1 is a General Purpose Amplifier that is internally input and output matched. It is designed for a broad range of Class A, small-signal, high linearity, general purpose applications. It is suitable for applications with frequencies from 0 to 6000 MHz such as Cellular, PCS, BWA, WLL, PHS, CATV, VHF, UHF, UMTS and general small-signal RF.

Features

- Frequency: 0 to 6000 MHz
- P1dB: 15 dBm @ 900 MHz
- Small-Signal Gain: 15 dB @ 900 MHz
- Third Order Output Intercept Point: 28 dBm @ 900 MHz
- Single 5 Volt Supply
- Internally Matched to 50 Ohms
- Low Cost SOT-89 Surface Mount Package
- RoHS Compliant
- In Tape and Reel. T1 Suffix = 1000 Units per 12 mm, 7 inch Reel.

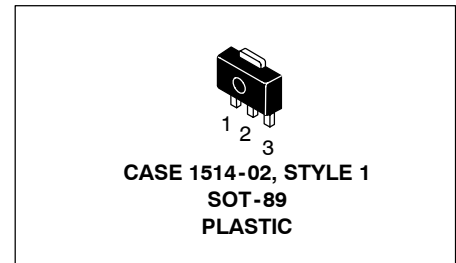
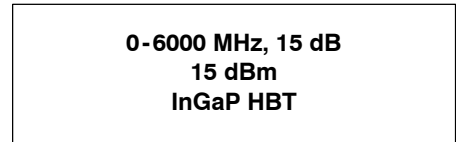

Table 1. Typical Performance ⁽¹⁾

Characteristic	Symbol	900 MHz	2140 MHz	3500 MHz	Unit
Small-Signal Gain (S21)	G _p	15	14	12	dB
Input Return Loss (S11)	IRL	-18	-25	-25	dB
Output Return Loss (S22)	ORL	-25	-18	-17	dB
Power Output @1dB Compression	P1db	15	13.5	13.5	dBm
Third Order Output Intercept Point	IP3	28	26.5	26	dBm

1. V_{CC} = 5 Vdc, T_C = 25°C, 50 ohm system

Table 2. Maximum Ratings

Rating	Symbol	Value	Unit
Supply Voltage	V _{CC}	6	V
Supply Current	I _{CC}	80	mA
RF Input Power	P _{in}	10	dBm
Storage Temperature Range	T _{stg}	-65 to +150	°C
Junction Temperature ⁽²⁾	T _J	150	°C

2. For reliable operation, the junction temperature should not exceed 150°C.

Table 3. Thermal Characteristics (V_{CC} = 5 Vdc, I_{CC} = 41 mA, T_C = 25°C)

Characteristic	Symbol	Value ⁽³⁾	Unit
Thermal Resistance, Junction to Case	R _{θJC}	83	°C/W

3. Refer to AN1955, *Thermal Measurement Methodology of RF Power Amplifiers*. Go to <http://www.freescale.com/rt>. Select Documentation/Application Notes - AN1955.

Table 4. Electrical Characteristics ($V_{CC} = 5$ Vdc, 900 MHz, $T_C = 25^\circ\text{C}$, 50 ohm system, in Freescale Application Circuit)

Characteristic	Symbol	Min	Typ	Max	Unit
Small-Signal Gain (S21)	G_p	13.5	15	—	dB
Input Return Loss (S11)	IRL	—	-18	—	dB
Output Return Loss (S22)	ORL	—	-25	—	dB
Power Output @ 1dB Compression	P1dB	—	15	—	dBm
Third Order Output Intercept Point	IP3	—	28	—	dBm
Noise Figure	NF	—	4.6	—	dB
Supply Current (1)	I_{CC}	32	41	48	mA
Supply Voltage (1)	V_{CC}	—	5	—	V

1. For reliable operation, the junction temperature should not exceed 150°C .

Table 5. Functional Pin Description

Pin Number	Pin Function
1	RF _{in}
2	Ground
3	RF _{out} /DC Supply

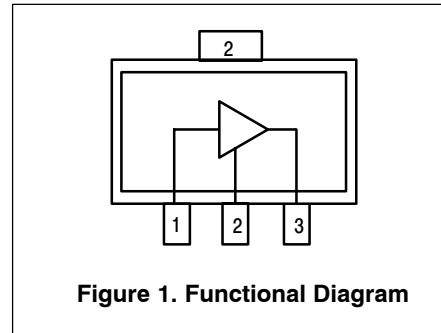
**Table 6. ESD Protection Characteristics**

Test Methodology	Class
Human Body Model (per JESD 22-A114)	1A (Minimum)
Machine Model (per EIA/JESD 22-A115)	A (Minimum)
Charge Device Model (per JESD 22-C101)	IV (Minimum)

Table 7. Moisture Sensitivity Level

Test Methodology	Rating	Package Peak Temperature	Unit
Per JESD 22-A113, IPC/JEDEC J-STD-020	1	260	°C

50 OHM TYPICAL CHARACTERISTICS

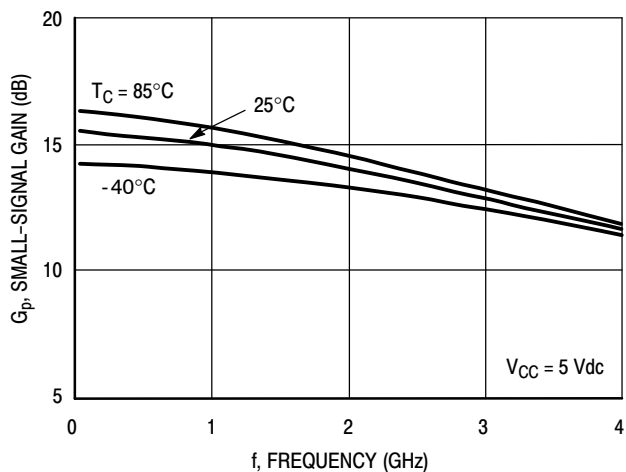

Figure 2. Small-Signal Gain (S21) versus Frequency

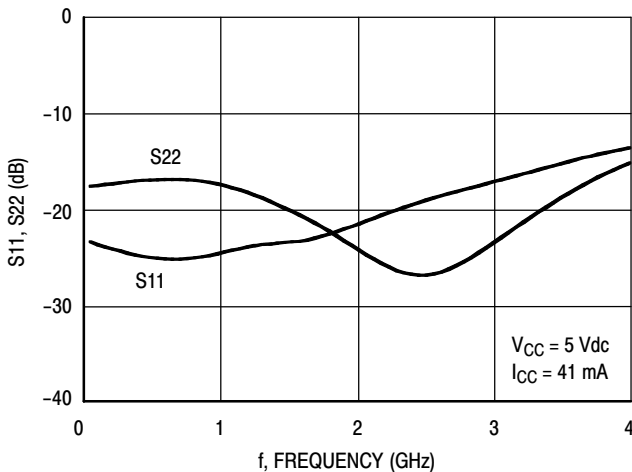

Figure 3. Input/Output Return Loss versus Frequency

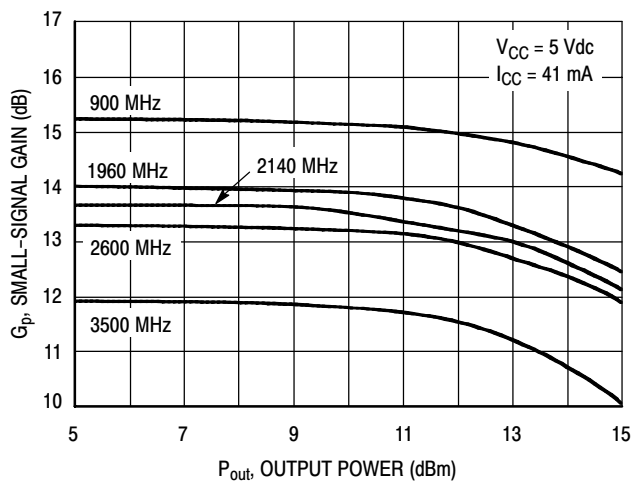

Figure 4. Small-Signal Gain versus Output Power

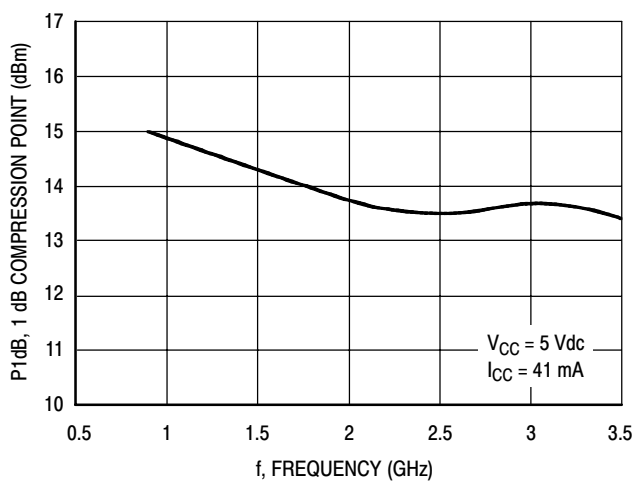

Figure 5. P1dB versus Frequency

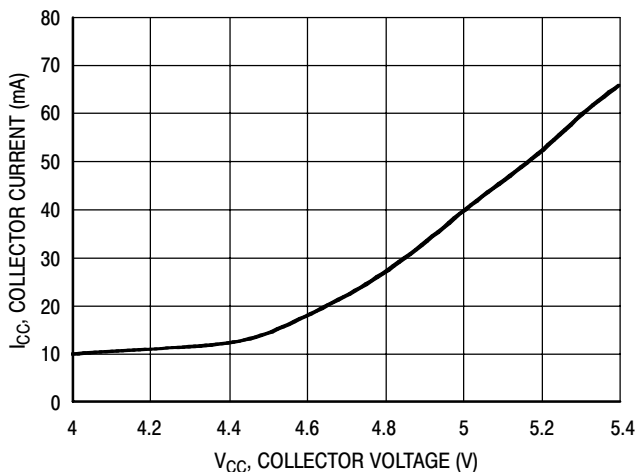

Figure 6. Collector Current versus Collector Voltage

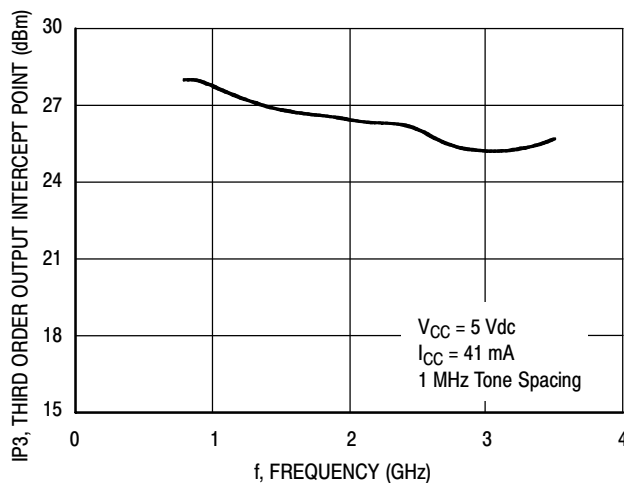

Figure 7. Third Order Output Intercept Point versus Frequency

50 OHM TYPICAL CHARACTERISTICS

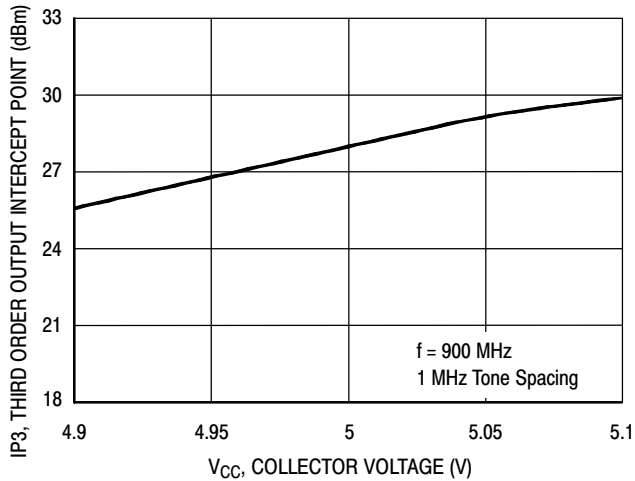

Figure 8. Third Order Output Intercept Point versus Collector Voltage

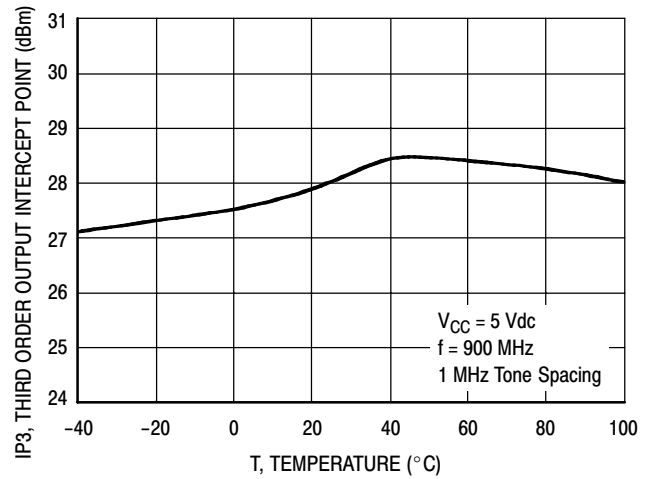

Figure 9. Third Order Output Intercept Point versus Case Temperature

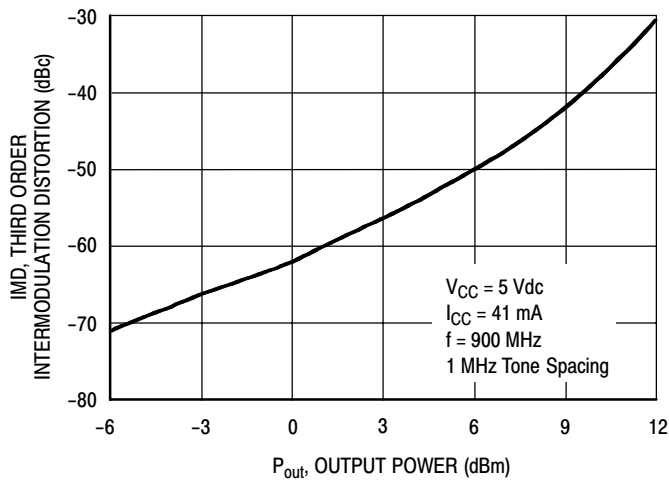
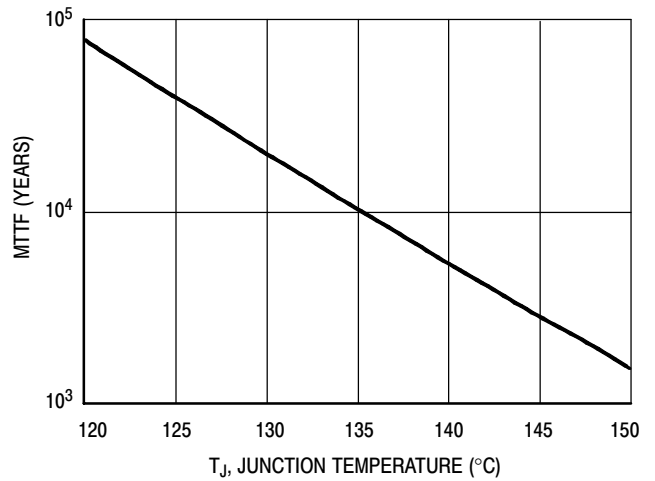

Figure 10. Third Order Intermodulation versus Output Power



NOTE: The MTTF is calculated with $V_{CC} = 5 \text{ Vdc}$, $I_{CC} = 41 \text{ mA}$

Figure 11. MTTF versus Junction Temperature

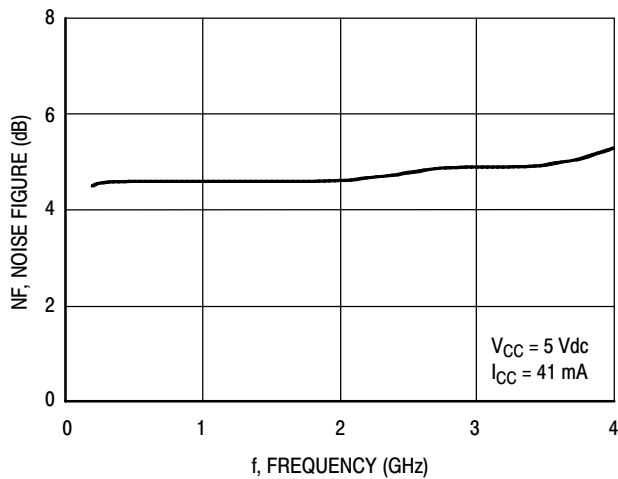

Figure 12. Noise Figure versus Frequency

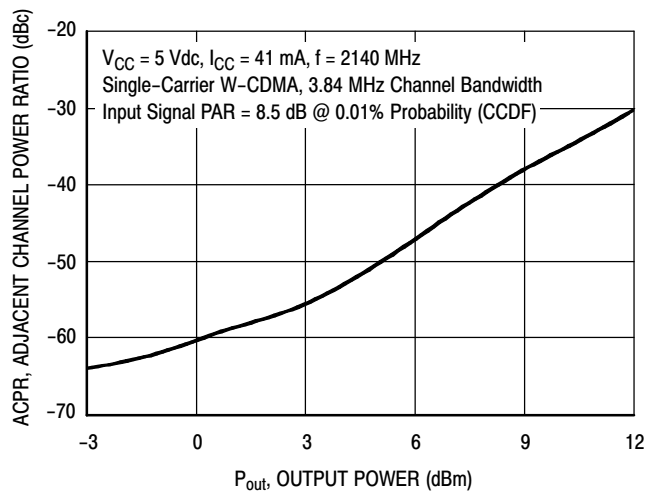

Figure 13. Single-Carrier W-CDMA Adjacent Channel Power Ratio versus Output Power

50 OHM APPLICATION CIRCUIT: 40-300 MHz

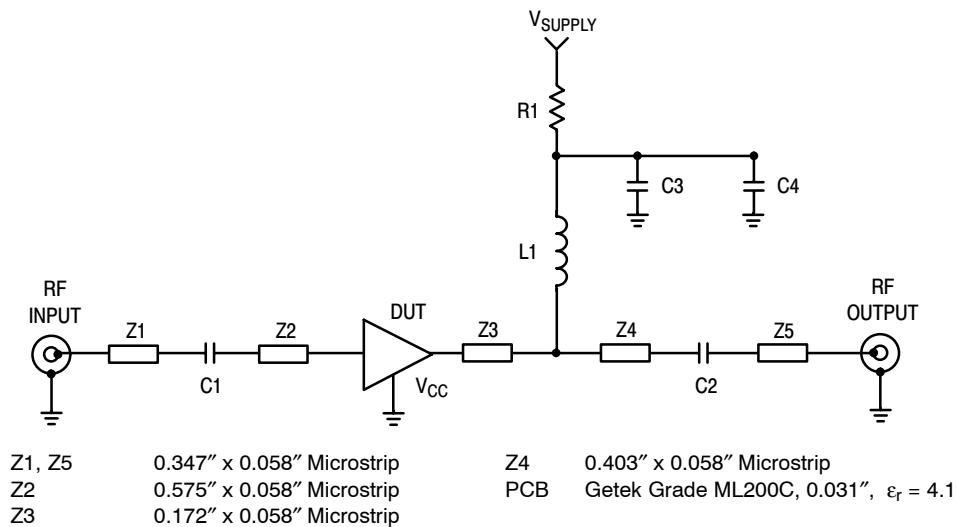

Figure 14. 50 Ohm Test Circuit Schematic

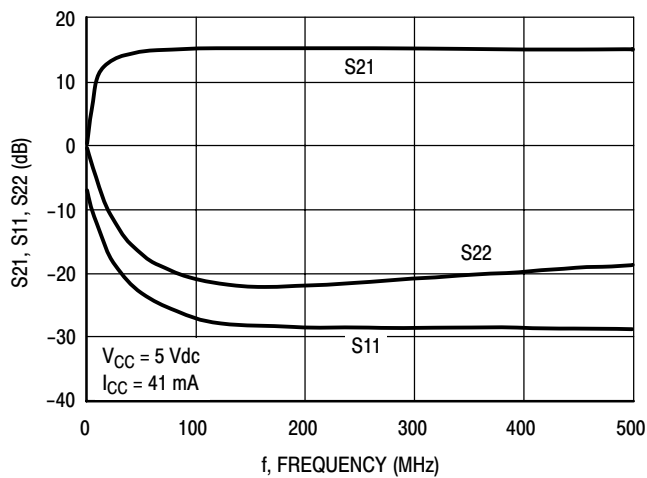

Figure 15. S21, S11 and S22 versus Frequency

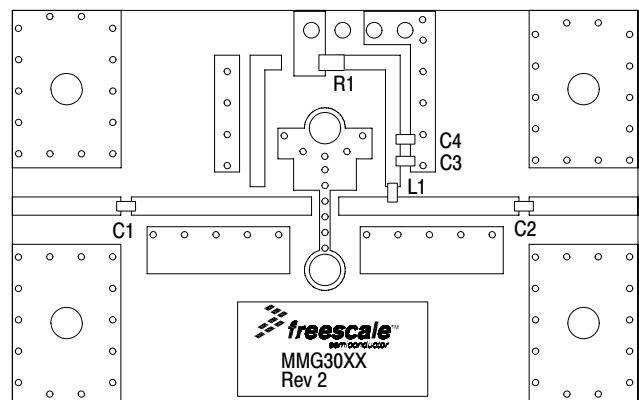

Figure 16. 50 Ohm Test Circuit Component Layout

Table 8. 50 Ohm Test Circuit Component Designations and Values

Part	Description	Part Number	Manufacturer
C1, C2, C3	0.01 μ F Chip Capacitors	C0603C103J5RAC	Kemet
C4	1000 pF Chip Capacitor	C0603C102J5RAC	Kemet
L1	470 nH Chip Inductor	BK2125HM471-T	Taiyo Yuden
R1	0 Ω Chip Resistor	ERJ3GEY0R00V	Panasonic

50 OHM APPLICATION CIRCUIT: 300-3600 MHz

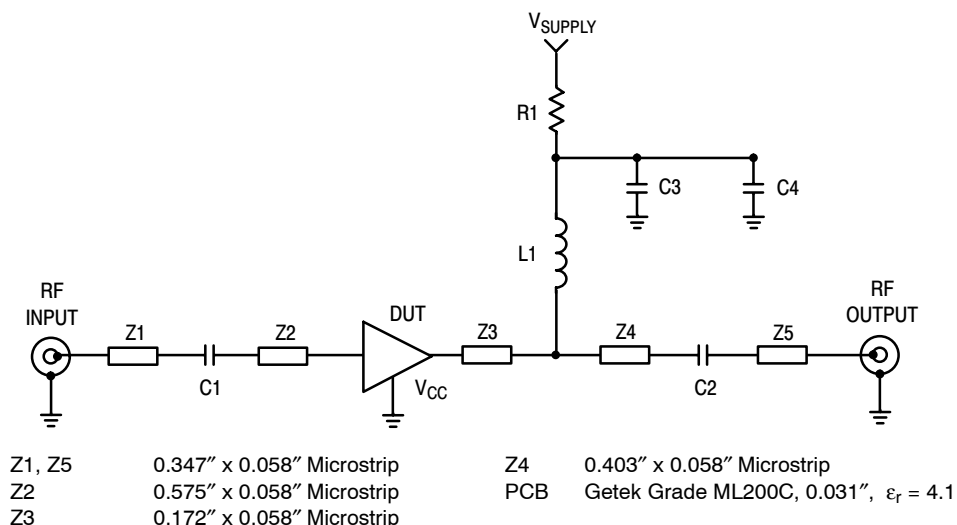

Figure 17. 50 Ohm Test Circuit Schematic

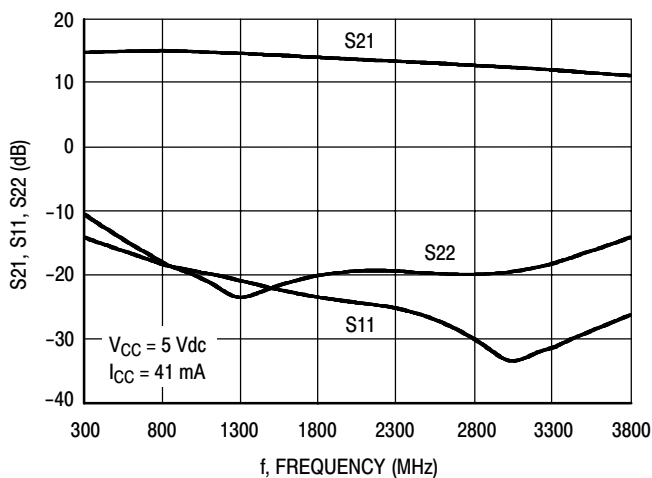

Figure 18. S21, S11 and S22 versus Frequency

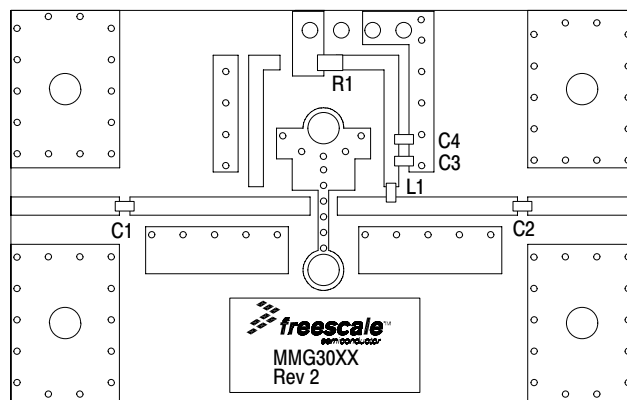

Figure 19. 50 Ohm Test Circuit Component Layout

Table 9. 50 Ohm Test Circuit Component Designations and Values

Part	Description	Part Number	Manufacturer
C1, C2	150 pF Chip Capacitors	C0603C151J5RAC	Kemet
C3	0.01 μ F Chip Capacitor	C0603C103J5RAC	Kemet
C4	1000 pF Chip Capacitor	C0603C102J5RAC	Kemet
L1	56 nH Chip Inductor	HK160856NJ-T	Taiyo Yuden
R1	0 Ω Chip Resistor	ERJ3GEY0R00V	Panasonic

50 OHM TYPICAL CHARACTERISTICS

Table 10. Common Emitter S-Parameters ($V_{CC} = 5 \text{ Vdc}$, $I_{CC} = 41 \text{ mA}$, $T_C = 25^\circ\text{C}$, 50 Ohm System)

f MHz	S ₁₁		S ₂₁		S ₁₂		S ₂₂	
	S ₁₁	∠ φ	S ₂₁	∠ φ	S ₁₂	∠ φ	S ₂₂	∠ φ
100	0.06552	170.033	5.96942	176.263	0.09975	-0.816	0.13385	-2.955
150	0.06383	167.931	5.93739	174.155	0.09991	-1.18	0.13500	-4.514
200	0.06269	165.117	5.91539	171.527	0.10015	-2.477	0.13601	-6.374
250	0.06117	162.063	5.89348	169.546	0.10045	-2.883	0.13724	-9.6
300	0.05981	158.66	5.87619	167.518	0.10063	-3.34	0.13832	-12.707
350	0.05830	154.766	5.86975	165.398	0.10085	-4.05	0.14046	-14.848
400	0.05702	150.967	5.85785	163.377	0.10108	-4.506	0.14191	-17.031
450	0.05620	147.157	5.84533	161.303	0.10131	-5.159	0.14371	-19.568
500	0.05480	143.805	5.83028	159.19	0.10142	-5.766	0.14461	-21.523
550	0.05404	139.862	5.81371	157.192	0.10154	-6.253	0.14562	-23.875
600	0.05345	136.215	5.79406	155.172	0.10159	-6.83	0.14624	-25.878
650	0.05300	132.595	5.77608	153.133	0.10166	-7.449	0.14664	-28.005
700	0.05301	129.164	5.75924	151.135	0.10172	-7.985	0.14651	-30.174
750	0.05337	125.784	5.73951	149.108	0.10177	-8.608	0.14648	-32.244
800	0.05401	122.842	5.71885	147.093	0.10184	-9.178	0.14551	-34.496
850	0.05502	120.061	5.69616	145.064	0.10204	-9.746	0.14435	-36.557
900	0.05607	117.736	5.67188	143.066	0.10209	-10.319	0.14281	-38.707
950	0.05712	115.541	5.65082	141.112	0.10222	-10.915	0.14087	-40.982
1000	0.05849	113.614	5.62851	139.109	0.10236	-11.506	0.13859	-43.169
1050	0.06056	112.274	5.60006	137.159	0.10243	-12.103	0.13641	-45.576
1100	0.06216	111.255	5.57557	135.169	0.10254	-12.71	0.13320	-47.809
1150	0.06385	110.823	5.55100	133.202	0.10280	-13.306	0.12952	-50.265
1200	0.06581	110.396	5.52258	131.231	0.10297	-13.892	0.12567	-52.695
1250	0.06795	110.14	5.49787	129.289	0.10307	-14.559	0.12169	-55.267
1300	0.07029	110.037	5.47256	127.359	0.10327	-15.203	0.11718	-57.902
1350	0.06417	110.3	5.44429	125.432	0.10350	-15.851	0.11263	-60.543
1400	0.06615	110.33	5.41593	123.531	0.10367	-16.46	0.10814	-63.335
1450	0.06834	110.566	5.38670	121.627	0.10385	-17.039	0.10311	-66.301
1500	0.07037	111.203	5.35727	119.73	0.10409	-17.682	0.09824	-69.317
1550	0.06361	106.262	5.33305	117.89	0.10444	-18.324	0.09725	-65.446
1600	0.06510	104.31	5.30415	116	0.10462	-18.939	0.09352	-67.448
1650	0.06709	103.387	5.26958	114.125	0.10474	-19.656	0.09017	-69.038
1700	0.06871	101.77	5.24166	112.251	0.10505	-20.294	0.08614	-71.347
1750	0.07086	100.502	5.21283	110.413	0.10523	-20.945	0.08224	-73.345
1800	0.07328	99.404	5.18411	108.549	0.10547	-21.577	0.07847	-75.924
1850	0.07577	98.261	5.15395	106.674	0.10576	-22.375	0.07419	-78.51
1900	0.07845	97.17	5.12325	104.849	0.10592	-23.012	0.07045	-81.64
1950	0.08096	96.588	5.09284	102.996	0.10612	-23.742	0.06627	-85.166
2000	0.08378	95.835	5.06020	101.184	0.10637	-24.419	0.06270	-88.825
2050	0.08710	94.791	5.03015	99.346	0.10667	-25.036	0.05860	-93.023
2100	0.08957	94.206	5.00175	97.519	0.10686	-25.835	0.05542	-97.743
2150	0.09160	93.044	4.96977	95.715	0.10722	-26.591	0.05191	-103.413
2200	0.09580	92.472	4.93541	93.926	0.10725	-27.253	0.04928	-109.11
2250	0.09801	91.352	4.90425	92.125	0.10767	-27.931	0.04677	-115.508

(continued)

50 OHM TYPICAL CHARACTERISTICS

Table 10. Common Emitter S-Parameters ($V_{CC} = 5 \text{ Vdc}$, $I_{CC} = 41 \text{ mA}$, $T_C = 25^\circ\text{C}$, 50 Ohm System) (continued)

f MHz	S ₁₁		S ₂₁		S ₁₂		S ₂₂	
	S ₁₁	∠ φ	S ₂₁	∠ φ	S ₁₂	∠ φ	S ₂₂	∠ φ
2300	0.10125	90.343	4.87215	90.327	0.10777	-28.67	0.04452	-122.296
2350	0.10384	89.16	4.84064	88.561	0.10817	-29.394	0.04294	-129.541
2400	0.10702	88.397	4.80597	86.77	0.10841	-30.211	0.04205	-138.1
2450	0.11008	87.519	4.77373	85.006	0.10869	-30.924	0.04158	-146.363
2500	0.11241	86.11	4.73852	83.289	0.10879	-31.661	0.04157	-154.578
2550	0.11540	85.045	4.71080	81.53	0.10916	-32.408	0.04231	-162.984
2600	0.11824	83.877	4.67765	79.803	0.10931	-33.203	0.04340	-171.06
2650	0.12090	82.346	4.64616	78.061	0.10958	-33.929	0.04508	-178.591
2700	0.12340	81.156	4.61372	76.324	0.10994	-34.621	0.04725	174.366
2750	0.12606	79.687	4.58063	74.605	0.10994	-35.444	0.05010	167.162
2800	0.12922	78.399	4.55022	72.881	0.11034	-36.246	0.05315	160.781
2850	0.13144	77.016	4.51863	71.172	0.11063	-37.03	0.05620	154.624
2900	0.13428	75.734	4.49057	69.495	0.11089	-37.754	0.06004	149.451
2950	0.13713	74.325	4.45366	67.734	0.11109	-38.64	0.06342	144.065
3000	0.13914	72.892	4.42536	66.061	0.11140	-39.407	0.06743	138.972
3050	0.14320	71.422	4.39730	64.387	0.11161	-40.164	0.07181	134.77
3100	0.14613	70.248	4.36561	62.698	0.11191	-40.968	0.07596	130.079
3150	0.14898	69.069	4.33420	61.007	0.11211	-41.861	0.08043	125.992
3200	0.15264	67.768	4.30556	59.316	0.11252	-42.74	0.08543	122.138
3250	0.15656	66.632	4.27446	57.648	0.11258	-43.528	0.09047	117.963
3300	0.15948	65.655	4.24479	55.984	0.11281	-44.448	0.09540	114.29
3350	0.16325	64.574	4.21546	54.301	0.11317	-45.247	0.10082	110.967
3400	0.16694	63.679	4.18743	52.638	0.11329	-46.134	0.10661	107.412
3450	0.17113	62.876	4.15740	50.961	0.11352	-46.992	0.11195	104.192
3500	0.17493	62.049	4.12688	49.288	0.11374	-47.856	0.11808	101.204
3550	0.17906	61.193	4.09892	47.63	0.11391	-48.768	0.12404	98.182
3600	0.18310	60.522	4.06981	45.971	0.11410	-49.604	0.13009	95.337

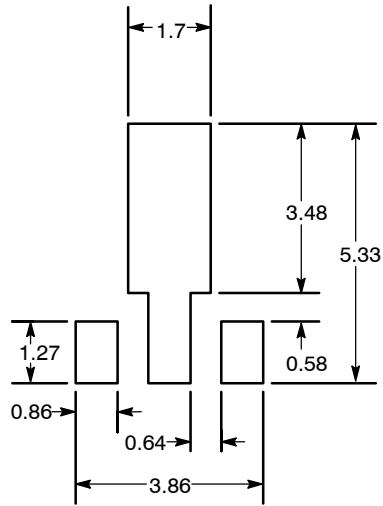

Recommended Solder Stencil

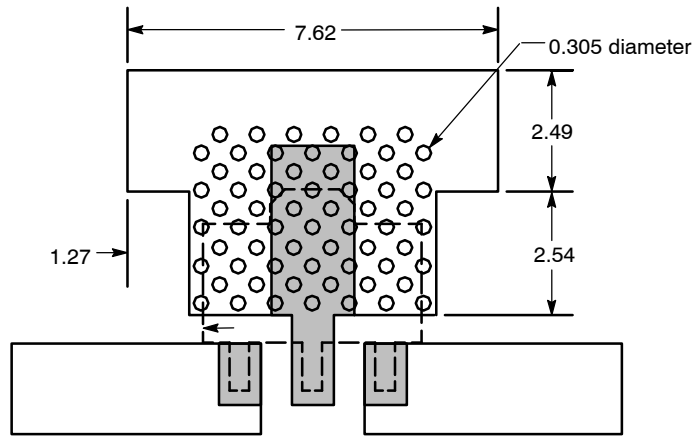

NOTES:

1. THERMAL AND RF GROUNDING CONSIDERATIONS SHOULD BE USED IN PCB LAYOUT DESIGN.
2. DEPENDING ON PCB DESIGN RULES, AS MANY VIAS AS POSSIBLE SHOULD BE PLACED ON THE LANDING PATTERN.
3. IF VIAS CANNOT BE PLACED ON THE LANDING PATTERN, THEN AS MANY VIAS AS POSSIBLE SHOULD BE PLACED AS CLOSE TO THE LANDING PATTERN AS POSSIBLE FOR OPTIMAL THERMAL AND RF PERFORMANCE.
4. RECOMMENDED VIA PATTERN SHOWN HAS 0.381 x 0.762 MM PITCH.

Figure 20. Recommended Mounting Configuration

PACKAGE DIMENSIONS

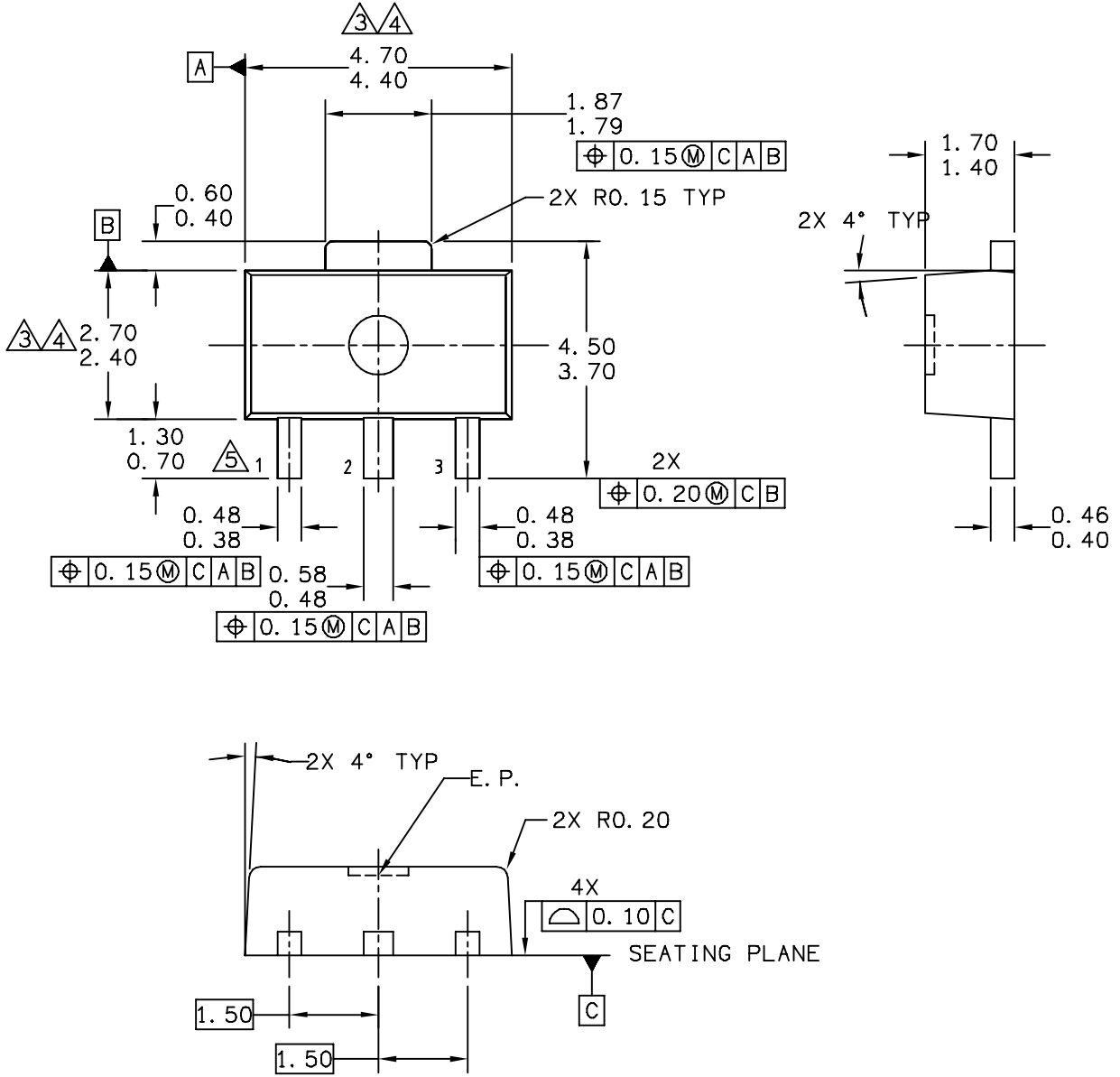

© FREESCALE SEMICONDUCTOR, INC. ALL RIGHTS RESERVED.	MECHANICAL OUTLINE	PRINT VERSION NOT TO SCALE	
TITLE: SOT-89, 4 LEAD, 4.5 X 2.5 PKG, 1.5 MM PITCH	DOCUMENT NO: 98ASA10586D	REV: D	
	CASE NUMBER: 1514-02	27 JUN 2007	
	STANDARD: NON-JEDEC		

MMG3011NT1

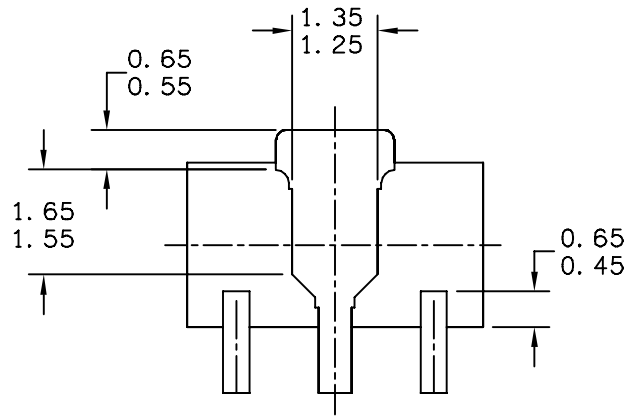

BOTTOM VIEW

CASE STYLE:

STYLE 1:

PIN 1. RF INPUT
 PIN 2. GROUND
 PIN 3. RF OUTPUT

STYLE 2:

PIN 1. GATE
 PIN 2. SOURCE
 PIN 3. DRAIN

© FREESCALE SEMICONDUCTOR, INC. ALL RIGHTS RESERVED.	MECHANICAL OUTLINE	PRINT VERSION NOT TO SCALE	
TITLE: SOT-89, 4 LEAD, 4.5 X 2.5 PKG, 1.5 MM PITCH	DOCUMENT NO: 98ASA10586D	REV: D	
	CASE NUMBER: 1514-02	27 JUN 2007	
	STANDARD: NON-JEDEC		

NOTES:

1 DIMENSIONING AND TOLERANCING PER ASME Y14.5M – 1994.

2 ALL DIMENSIONS ARE IN MILLIMETERS.

3 DIMENSIONS DOES NOT INCLUDE MOLD FLASH, PROTRUSIONS OR GATE BURRS. MOLD FLASH, PROTRUSIONS OR GATE BURRS SHALL NOT EXCEED 0.5mm PER END. DIMENSION DOES NOT INCLUDE INTERLEAD FLASH OR PROTRUSION. INTERLEAD FLASH OR PROTRUSION SHALL NOT EXCEED 0.5 mm PER SIDE.

4 DIMENSION ARE DETERMINED AT THE OUTMOST EXTREMES OF THE PLASTIC BODY EXCLUSIVE OF MOLD FLASH, TIE BAR BURRS, GATE BURRS AND INTERLEAD FLASH, BUT INCLUDING ANY MISMATCH BETWEEN THE TOP AND BOTTOM OF THE PLASTIC BODY.

5 TERMINAL NUMBERS ARE SHOWN FOR REFERENCE ONLY.

© FREESCALE SEMICONDUCTOR, INC. ALL RIGHTS RESERVED.	MECHANICAL OUTLINE	PRINT VERSION NOT TO SCALE	
TITLE: SOT-89, 4 LEAD, 4.5 X 2.5 PKG, 1.5 MM PITCH	DOCUMENT NO: 98ASA10586D	REV: D	
	CASE NUMBER: 1514-02	27 JUN 2007	
	STANDARD: NON-JEDEC		

PRODUCT DOCUMENTATION

Refer to the following documents to aid your design process.

Application Notes

- AN1955: Thermal Measurement Methodology of RF Power Amplifiers
- AN3100: General Purpose Amplifier Biasing

REVISION HISTORY

The following table summarizes revisions to this document.

Revision	Date	Description
3	Mar. 2007	<ul style="list-style-type: none">• Corrected and updated Part Numbers in Tables 8 and 9, Component Designations and Values, to RoHS compliant part numbers, p. 6, 7
4	July 2007	<ul style="list-style-type: none">• Replaced Case Outline 1514-01 with 1514-02, Issue D, p. 1, 11-13. Case updated to add missing dimension for Pin 1 and Pin 3.
5	Mar. 2008	<ul style="list-style-type: none">• Removed Footnote 2, Continuous voltage and current applied to device, from Table 2, Maximum Ratings, p. 1• Corrected Fig. 13, Single-Carrier W-CDMA Adjacent Channel Power Ratio versus Output Power y-axis (ACPR) unit of measure to dBc, p. 5• Corrected S-Parameter table frequency column label to read "MHz" versus "GHz" and corrected frequency values from GHz to MHz, p. 8, 9

How to Reach Us:

Home Page:

www.freescale.com

Web Support:

<http://www.freescale.com/support>

USA/Europe or Locations Not Listed:

Freescale Semiconductor, Inc.
Technical Information Center, EL516
2100 East Elliot Road
Tempe, Arizona 85284
+1-800-521-6274 or +1-480-768-2130
www.freescale.com/support

Europe, Middle East, and Africa:

Freescale Halbleiter Deutschland GmbH
Technical Information Center
Schatzbogen 7
81829 Muenchen, Germany
+44 1296 380 456 (English)
+46 8 52200080 (English)
+49 89 92103 559 (German)
+33 1 69 35 48 48 (French)
www.freescale.com/support

Japan:

Freescale Semiconductor Japan Ltd.
Headquarters
ARCO Tower 15F
1-8-1, Shimo-Meguro, Meguro-ku,
Tokyo 153-0064
Japan
0120 191014 or +81 3 5437 9125
support.japan@freescale.com

Asia/Pacific:

Freescale Semiconductor Hong Kong Ltd.
Technical Information Center
2 Dai King Street
Tai Po Industrial Estate
Tai Po, N.T., Hong Kong
+800 2666 8080
support.asia@freescale.com

For Literature Requests Only:

Freescale Semiconductor Literature Distribution Center
P.O. Box 5405
Denver, Colorado 80217
1-800-441-2447 or 303-675-2140
Fax: 303-675-2150
LDCForFreescaleSemiconductor@hibbertgroup.com

Information in this document is provided solely to enable system and software implementers to use Freescale Semiconductor products. There are no express or implied copyright licenses granted hereunder to design or fabricate any integrated circuits or integrated circuits based on the information in this document.

Freescale Semiconductor reserves the right to make changes without further notice to any products herein. Freescale Semiconductor makes no warranty, representation or guarantee regarding the suitability of its products for any particular purpose, nor does Freescale Semiconductor assume any liability arising out of the application or use of any product or circuit, and specifically disclaims any and all liability, including without limitation consequential or incidental damages. "Typical" parameters that may be provided in Freescale Semiconductor data sheets and/or specifications can and do vary in different applications and actual performance may vary over time. All operating parameters, including "Typicals", must be validated for each customer application by customer's technical experts. Freescale Semiconductor does not convey any license under its patent rights nor the rights of others. Freescale Semiconductor products are not designed, intended, or authorized for use as components in systems intended for surgical implant into the body, or other applications intended to support or sustain life, or for any other application in which the failure of the Freescale Semiconductor product could create a situation where personal injury or death may occur. Should Buyer purchase or use Freescale Semiconductor products for any such unintended or unauthorized application, Buyer shall indemnify and hold Freescale Semiconductor and its officers, employees, subsidiaries, affiliates, and distributors harmless against all claims, costs, damages, and expenses, and reasonable attorney fees arising out of, directly or indirectly, any claim of personal injury or death associated with such unintended or unauthorized use, even if such claim alleges that Freescale Semiconductor was negligent regarding the design or manufacture of the part.

Freescale™ and the Freescale logo are trademarks of Freescale Semiconductor, Inc. All other product or service names are the property of their respective owners.

© Freescale Semiconductor, Inc. 2005-2008. All rights reserved.

